

# Toggle Bolt / Tapping Screws Mounting Guide

## AP700 Series

**A** \* Toggle Bolt x 2



**B** \* Tapping Screws x 2



**C** \* Hanging Cable x 2

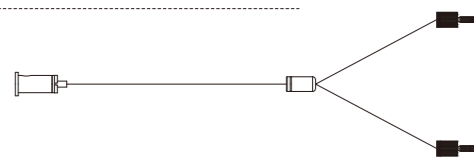

### Toggle Bolt Installation

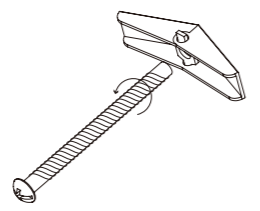

**Step 1.1**  
Remove the (A) screws from the toggle bolts.

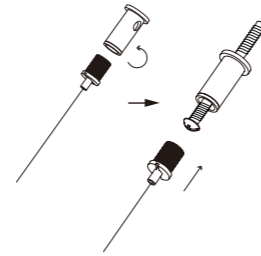

**Step 1.2**  
Loosen the top part of the hanging cable (C) and put the (A) screws in.

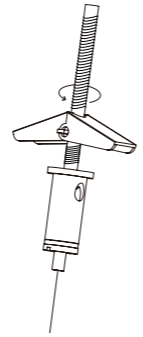

**Step 2.1**  
Screw the toggle bolts into the hanging cable (C).

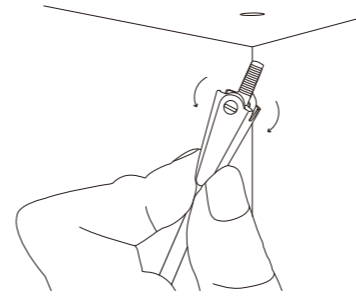

**Step 2.2**  
Squeeze the sides of the toggle bolt (A), then insert into a pre-drilled hole.  
\*Hole Size - Min: 5/8"(16mm) / Max: 1"(25mm)

### Tapping Screws Installation

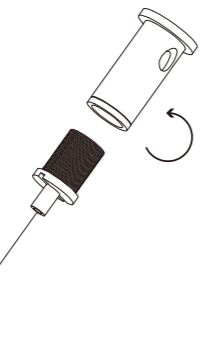

**Step 1.**  
Loosen the top part of the hanging cable (C)

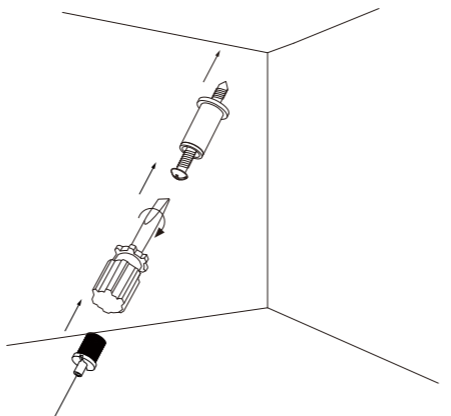

**Step 2.**  
Screw the (B) screws in the wall tightly.

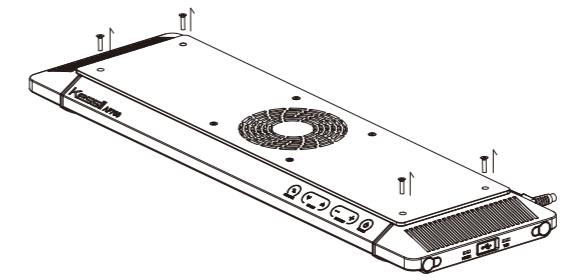

**Step 3.**  
Remove the four corner screws from the AP700 using the hex wrench.

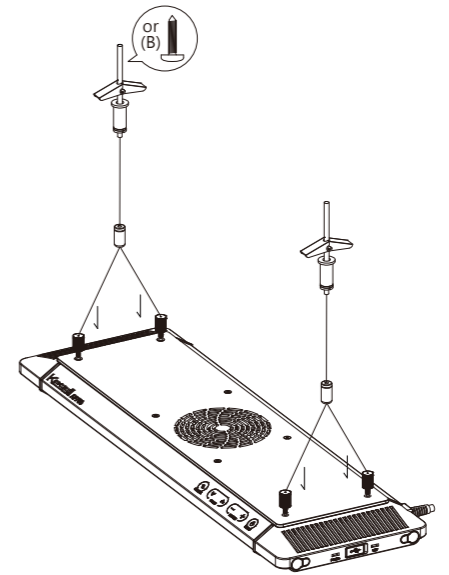

**Step 4.**  
Screw the hanging cable (C) into the corners of the AP700. You are finished!



**Kessil Lighting**  
A DiCon Brand  
1689 Regatta Blvd,  
Richmond, CA 94804  
(510) 620-5250